



AQUAPURA MONOBLOC

120i



Esteemed Client,

We would like to thank you for your choice when you acquired an equipment for sanitary water heating.

AQUAPURA MONOBLOC aero-thermal system will surely meet all your expectations and provide many years of comfort with maximum power saving.

Our organization dedicates much time, energy and economic resources in order to develop innovations that will promote power saving in our products.

Your choice has demonstrated your good sense and concern with power consumption, a matter that affects the environment.

We have taken on a permanent commitment to conceive innovative and efficient products so that this rational use of energy can actively contribute to the preservation of the environment and natural resources of the planet.

Keep this manual whose objective is to inform, alert and advise about the use and maintenance of this equipment.

Our services are always at your disposal. Feel free to call upon us!



Index

1. INTRO	6
1.1. Symbols.....	6
1.2. Pre-installation Information	6
1.3. Safety Information	7
2. SPECIFICATIONS.....	8
2.1. Components	8
2.2. Running Principle	9
2.3. Technical Data	10
3. TRANSPORT	11
4. INSTALLATION.....	11
4.1. Safety and Control Devices	11
4.1.1. High/Low Pressure Switch.....	11
4.1.2. Safety Thermostat.....	11
4.1.3. Temperature Probe.....	11
4.1.4. Expansion Vessel*	11
4.1.5. Safety Group*	12
4.1.6. Pressure Reducing Valve*	12
4.2. Positioning	13
4.3. Air Inlet/Outlet Installation	14
4.3.1. Installation without Ducts	14
4.3.2. Installation with Ducts.....	14
4.4. Hydraulic Installation	17
4.5. Thermodynamic Group Access	18
4.6. Condensates	19
4.7. Electrical Connections	19
4.8. Electrical Diagram	20
5. CONTROL and PROGRAMMING	21
5.1. Control Panel.....	21
5.2. Keys (Functions).....	21
5.3. Display.....	21
5.4. User Interface.....	22
5.5. Operating Modes	23
5.6. Anti-Legionella Function	23
6. ERRORS.....	24
7. PROBE CHART.....	24
8. TROUBLESHOOTING	25
9. SYSTEM MAINTENANCE.....	27
9.1. General Inspection	27
9.2. Empty the Water Storage.....	27
9.3. Filter of Reduction Valve	27

9.4. Condensate circuit.....27
9.5. Cleaning Air Circuit.....27
9.6. Safety Thermostat28

1. INTRO

1.1. Symbols

	<p>Every process that the supplier believes to be conducive to harmful danger and/or material damage will be signalled with a danger sign.</p> <p>To better characterize the danger, the symbol will be followed by one of these words:</p> <ul style="list-style-type: none"> • DANGER: when there is the possibility of harm to the operator and/or people in the vicinity of the equipment • WARNING: when there is the possibility of material damage to the equipment and/or attached materials.
	<p>All the information that the supplier believes to be an asset for better performance and preservation of the equipment, will be signalled together with the information sign.</p>

1.2. Pre-installation Information

 WARNING/DANGER	
<p>The electrical installation of the equipment must comply with the national regulations for electrical installations in effect.</p> <p>AquaPura Monobloc will only operate after receiving its load of coolant.</p> <p>The maximum water pressure into the hydraulic circuit inlet is 0.3 MPa and the minimum pressure is 0.1 MPa.</p> <p>The power supply is 230 V, 50 Hz, and the power supply cable is plugged into a socket with earth wiring. If the power supply cable is damaged, it must be replaced by the manufacturer, by its customer service, or by staff with similar training in order to avoid any danger.</p> <p>AquaPura Monobloc will only operate if the storage water heater is filled with water. Heating of other fluid than drinking water is not allowed.</p>	

1.3. Safety Information

	<p>Every process that the supplier believes to be conducive to harmful danger and/or material damage will be signalled with a danger sign. To better characterize the danger, the symbol will be followed by one of these words:</p> <ul style="list-style-type: none"> • DANGER: when there is the possibility of harm to the operator and/or people in the vicinity of the equipment • WARNING: when there is the possibility of material damage to the equipment and/or attached materials.
---	--

 <p>INFORMATION</p>
<p>When installing:</p> <ul style="list-style-type: none"> • The installation of heat pump equipment for heating sanitary water must be carried out by staff with suitable training and qualified for this purpose; • The device should not be installed in places that present a risk of impact, shock or explosion; • Keep the equipment packed until you reach the place and time of installation; • Make sure all hydraulic couplings are watertight before connecting the equipment to the power supply. <p>Maintenance of the equipment:</p> <ul style="list-style-type: none"> • Equipment maintenance should be carried out by customer service, except operations of general and continuous cleaning which could/should be carried out by the user; • Power supply to the equipment must be disconnected during maintenance operations; • The supplier recommends at least one annual inspection to the equipment, by a qualified technician; • Cleaning and maintenance must not be carried out by children unless they are under supervision <p>High pressure and temperature:</p> <ul style="list-style-type: none"> • The principle for running this equipment is directly linked to high temperature and pressure; thus, the processes that imply contact with the equipment, must be thought out with caution to prevent the risk of burns and projection of material; <p>Refrigerant:</p> <ul style="list-style-type: none"> • The refrigerant used in the entire process is R134a, CFC-free, non-inflammable and without harmful effects to the ozone layer; • However, according to the law, the fluid in this equipment cannot be released into the environment; • Handling of the fluid in the equipment must be carried out by a qualified technician. <p>Information for the Client:</p> <ul style="list-style-type: none"> ▪ The Installer must inform the client about the running of the equipment, its dangers, rights and duties of the client;

2. SPECIFICATIONS

2.1. Components

The AquaPura Monobloc 120L package contains:

- Hot water storage heater, in stainless steel:

Dimensions:

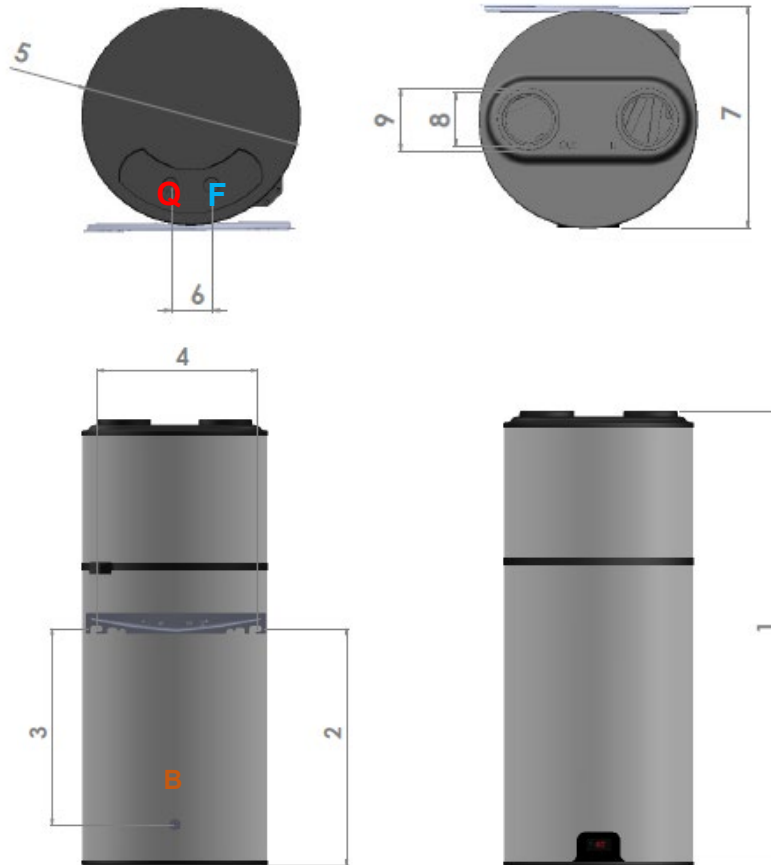

	120
1	1350 mm
2	808 mm
3	693 mm
4	450 mm
5	Ø530 mm
6	100 mm
7	550 mm
8	Ø125 mm
9	Ø150 mm
Q	3/4" M
F	3/4" M

- H** – Hot Water
- C** – Cold Water
- D** – Drain
- B** – Backstop

- A cooling system, at the top, responsible for transferring heat from ambient air to sanitary water;

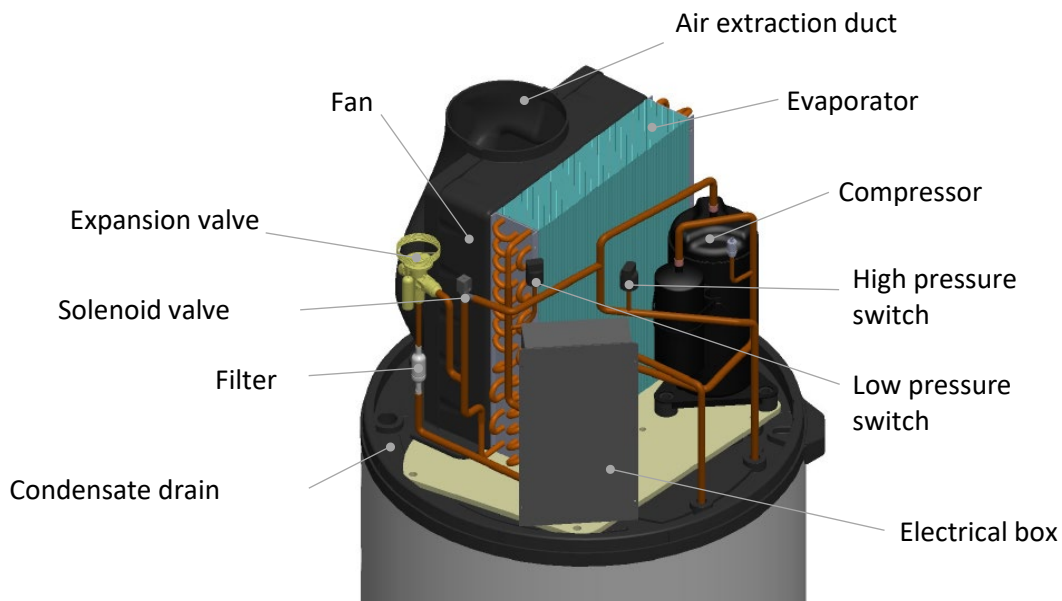

2.2. Running Principle

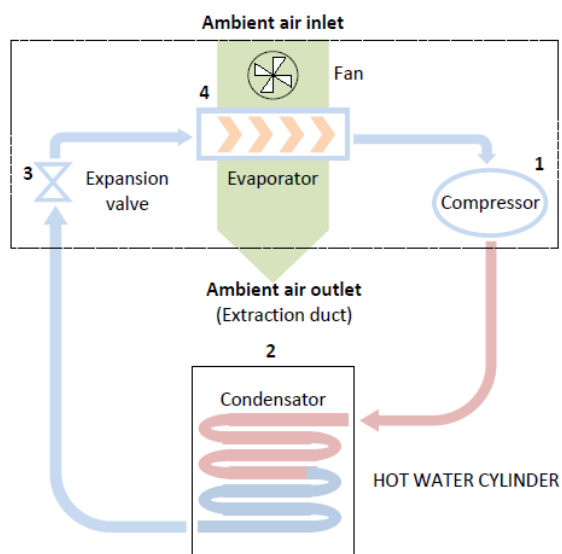

1. The cooling fluid (R134a) is compressed in the high efficient compressor, raising its pressure and temperature;
2. In the condenser (not in direct contact with the water), the heat energy in the cooling fluid is transmitted to the water in the water storage heater;
3. The condensate fluid (high pressure) runs from the expansion valve which is responsible for easing the its pressure;
4. The fluid absorbs heat energy from the environment by flowing through the evaporator with the help of a fan;



The R134a is a HFC fluid, thus not harmful to the ozone layer. It has great chemical and thermal stability, low toxicity, non-inflammable, and is compatible with most materials.

2.3. Technical Data

	Unit	120i
Type of Equipment	-	Air/Water Heat Pump for DHW
Nominal Capacity	L	114
Empty Weight	Kg	43
Dimensions (ø/height)	-	Ø530/1350
Storage Water Heater Material	-	Stainless Steel
Insulation	-	High-density polyurethane 50mm
Max Running Temperature	°C	80
Max Working Pressure	bar	7
Test Pressure	bar	10
Heat Loss	kWh/24h	0,95
Protection Index	-	IPX1
Power Supply	-	220-240 Vac / monophasic / 50 Hz
Absorbed Power (med / max)	W	250/350
Absorbed Power Electrical Support	W	1500
Thermal Power Supplied BC	W	1550
Ventilator Power	W	65
Max Running Current	A	1,6 + 6,8 (with backup electrical heater)
Max DHW Temperature (BC)	°C	60
Max DHW Temperature (Backup)	°C	70
Refrigerant	-/kg	R 134a / 0,7
Load Profile	-	M
COP ¹⁾	-	2,8
Heating Time ¹⁾	(hh:mm)	05:30
Amount of Useful Water 40°C ¹⁾	L	139
Energy Efficiency Class ¹⁾	-	A+
Energy Efficiency ¹⁾	%	117
Annual Electricity Consumption ¹⁾	kWh/year	438
Ambient Temperature Limits	°C	-5/40
Sound Power Level Indoor ²⁾	dB(A)	49
Sound Pressure at 2m	dB(A)	34
Air Flow	m ³ /h	195
Static Pressure Fan	Pa	60
Max Ducts Length	m	20





1) A14/W10-54, according EN16147 and Delegated Regulation No. 812/2013

2) According with EN12102

3. TRANSPORT

	<p>The equipment must be carried in an upright position. The equipment must be raised and lowered with extreme care, to avoid impact that could damage the material. Make sure the belts and/or transportation straps do not damage the material. Always use suitable means to transport the material (pallet lift, forklift, etc.)</p>
---	--

The equipment must be transported in its original package to the place of installation.
 The packages contain the following information symbols:

	<p>Fragile, handle with extreme caution</p>		<p>Keep the package dry</p>
	<p>Make sure the arrows are always up</p>		<p>Do not stack packages</p>

4. INSTALLATION

4.1. Safety and Control Devices

4.1.1. High/Low Pressure Switch

In case of running outside the range of pressures recommended and defined by the supplier, the equipment will switch off and indicate error in the electronic panel.

4.1.2. Safety Thermostat

The safety thermostat is set by the supplier to ensure that the water temperature in the storage water heater does not exceed the standard value. If the temperature exceeds this value, the thermostat switches off the backup electrical heater. Switching on is done manually by qualified staff, after analysing the reasons for the switch off.

4.1.3. Temperature Probe

The purpose of the temperature probe is to measure the temperature values of water in the storage water heater in order to control the system.

4.1.4. Expansion Vessel*

The expansion vessel is a device whose purpose is to compensate for the increase in water volume due to temperature rise.

4.1.5. Safety Group*

The safety device allows the system to be protected against anomaly situations: cold water supply, hot water flowing back, emptying of the storage water heater and high pressure. The valve is calibrated to activate at 0.7 MPa).

To drain the water in the storage water heater, you should close the supply valve and open the discharge valve.

The safety valve discharge pipe must be open into the atmosphere, because the valve may drip water or even discharge water.

The safety valve must be opened regularly to remove impurities and check that it is not blocked. The discharge pipe must be installed in a vertical position. The discharge pipe must be installed upright away from a cold environment.



Installing this device is recommended **as mandatory** for the proper installation of the equipment. Installing this device is the responsibility of the installer.
As a general rule it is installed in the cold water pipe.

4.1.6. Pressure Reducing Valve*

The pressure reducing valve must always be installed upstream from the safety device, and ready to activate in situations when the pressure in the circuit exceeds 3 bar (0.3MPa). This valve comes with a pressure gauge.

***Parts not supplied by the manufacturer. They must be installed by the installer.**

4.2. Positioning



Before starting to assemble the equipment, check the support capacity of the wall and the material it is made of, considering the weight of the equipment filled with water.

When placing the equipment in its position, bear in mind possible future interventions. Make sure that there is at least the following free space around the equipment:

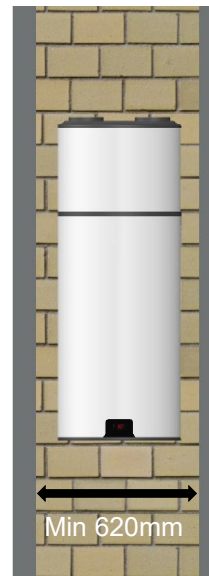
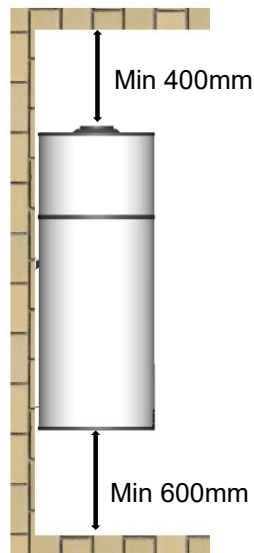

Adjust the levelling feet of the equipment. An inclination angle of up to 1° tilting backwards is acceptable.



If equipment tilts other than backwards, this will cause condensates to deposit in the tank.

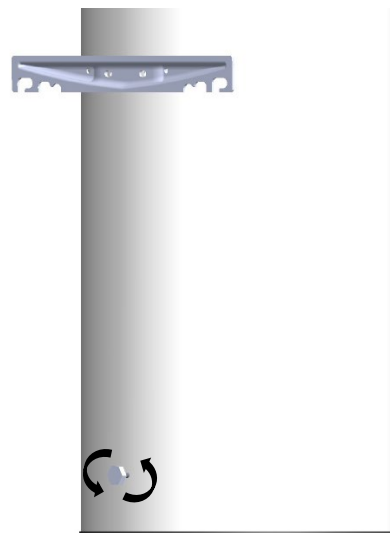

4.3. Air Inlet/Outlet Installation



As the AquaPura Monobloc absorbs heat during its operation, the air flow (inlet/outlet) must be directed to unheated areas. The equipment will cool the room where it is placed and so if it is installed in heater rooms, the air flow must be directed to other rooms and/or the outside.

4.3.1. Installation without Ducts

The **AquaPura Monobloc** equipment must be installed in a place that is not too heated, and may be used for dehumidifying and cooling these rooms (e.g., laundries, cellars, etc). Distance between the top of the unit and the ceiling must be no less than 600mm.

If the distance between the unit and the ceiling is less than 600mm, two elbow-type joints must be installed as shown in the following picture.

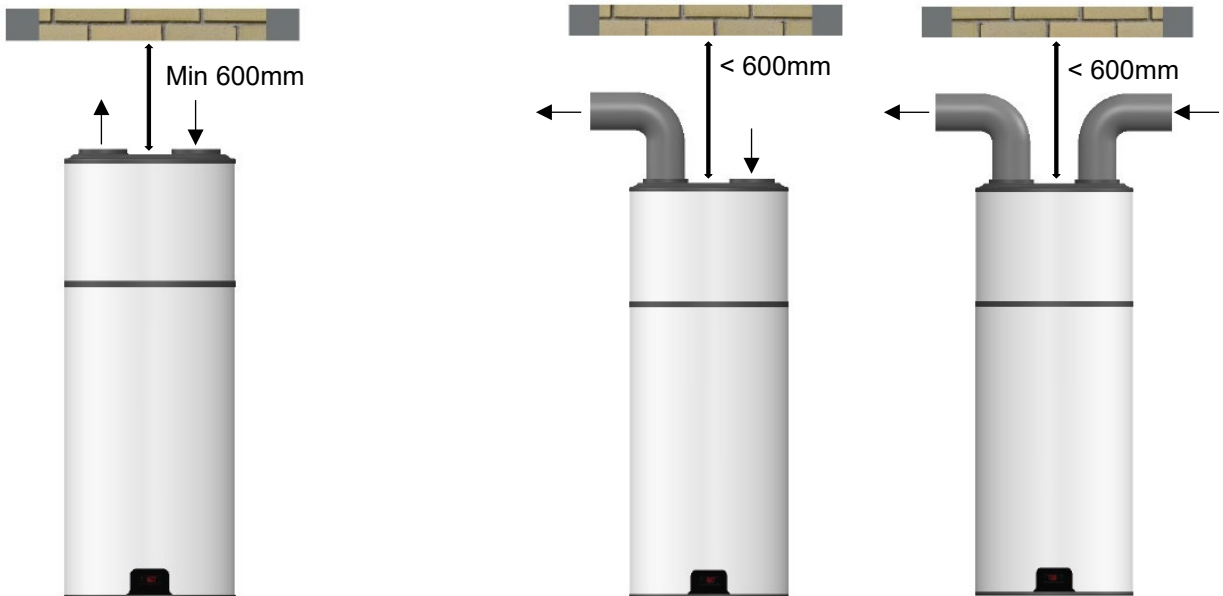

4.3.2. Installation with Ducts

The AquaPura Monobloc is prepared to install ducts with diameter of 125 mm and 150 mm, in its air intake and extraction zones:

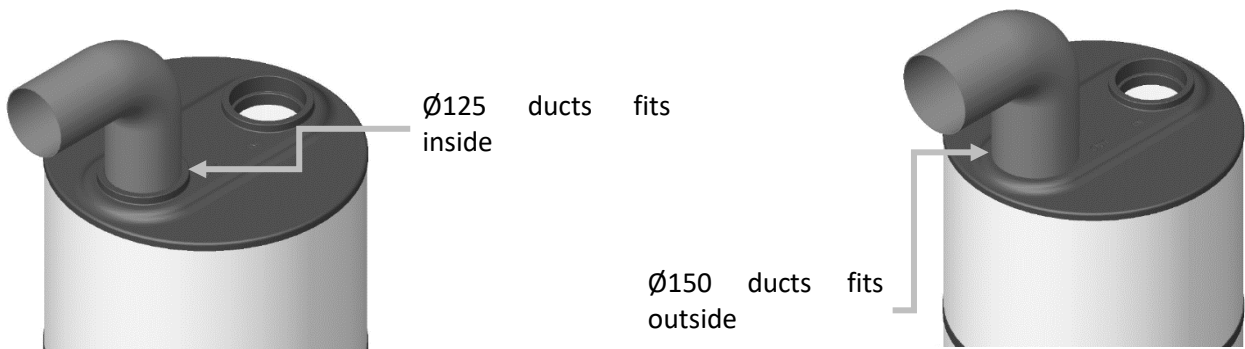

		Max Length Ducts	
		Ø125	Ø150
Rigid duct ¹⁾	m	10	20
Flexible duct ¹⁾	m	6	12

1) Considering 90° curves and louvers at the air inlet and outlet of the equipment.

If ducts are used, directing the air flow to areas that do not require heating, there are some options:

Using Outside Air

If outside air is used, the unit may be placed either in a heated room or in an unheated room.

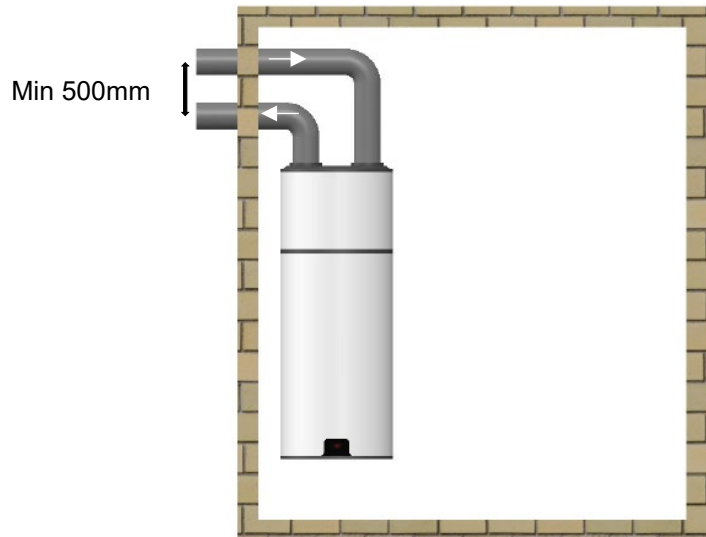

Using Ambient Air

The monobloc unit may also be placed in a heated room, but the air flow must be directed to an unheated room. Bear in mind that because of air flow, cooling the unheated room can affect the adjacent heated rooms.

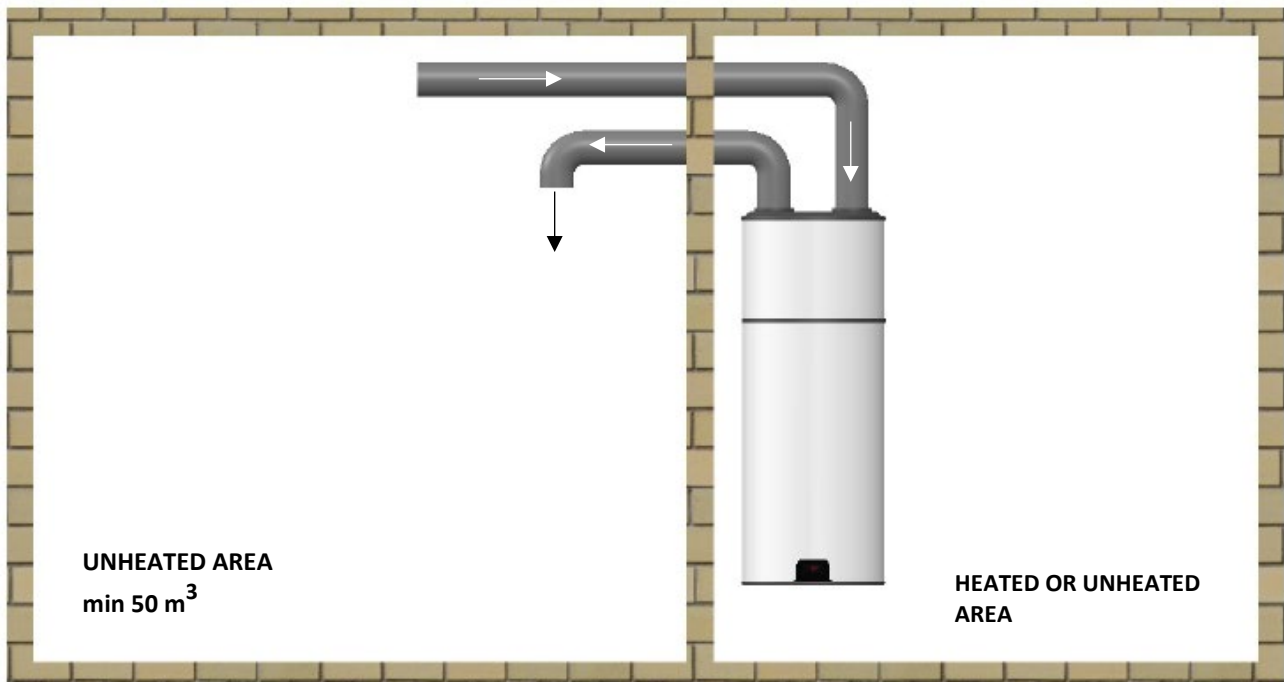

Using Ambient and Outside Air

A branched duct can be used to inflate air into the equipment. So you can get hot air in the summer, from the outside, and hot air in the winter from an unheated room.

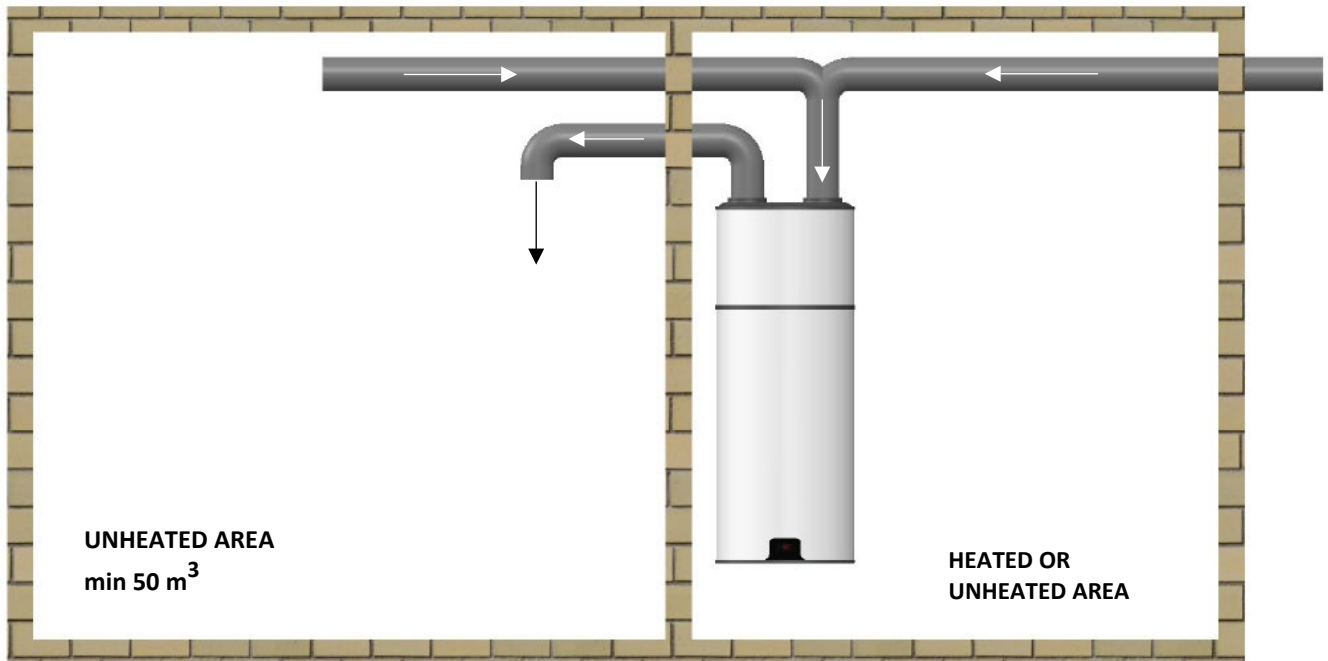

Ducts used to direct the airflow are not included in the equipment, and it is up to the installer to install them, if necessary, to comply with the manufacturer's recommendations.

Diameter of pipes must be of 125 mm or 150mm.

Pipes must not exceed 20 m in length.

4.4. Hydraulic Installation

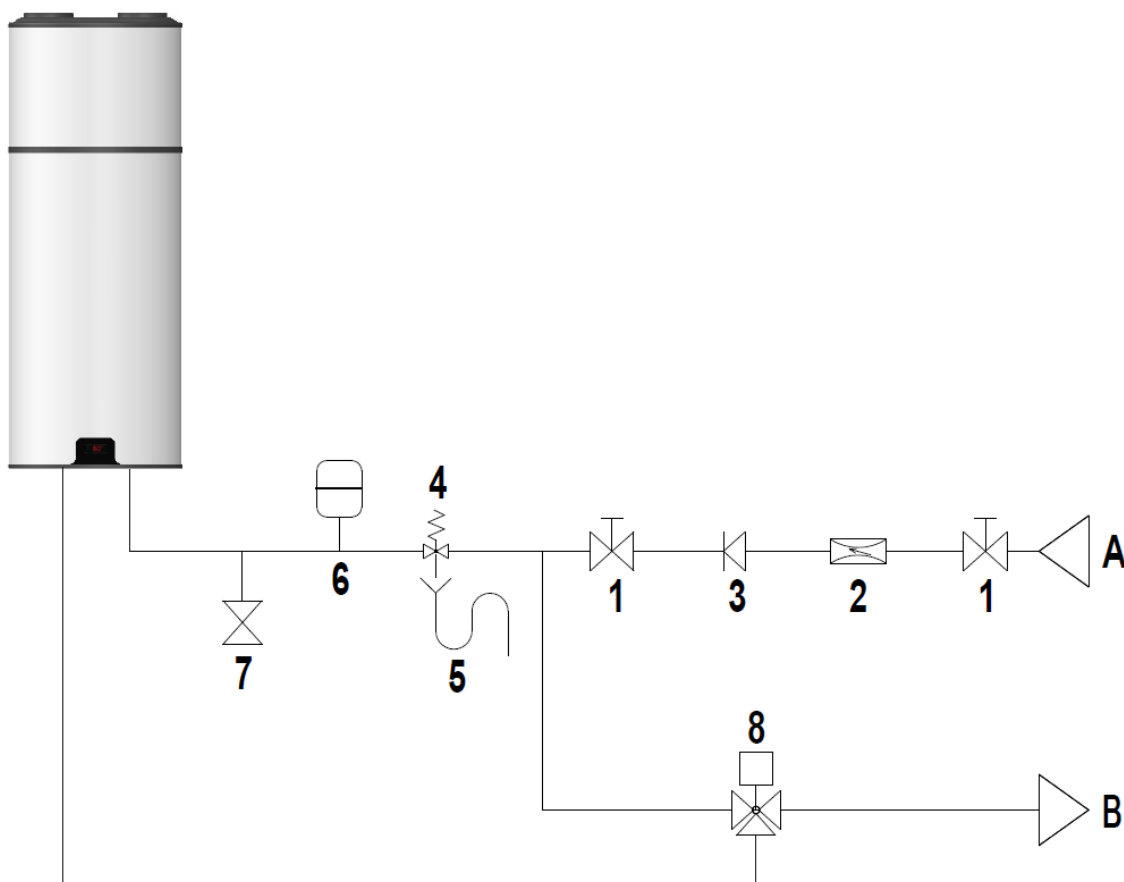

Caption

- | | |
|---|-----------------------------|
| 1 Shut Off Valve | 7 Drain Valve |
| 2 Pressure Reducing Valve (3 bar / 0,3 MPa) | 8 Circulating Pump |
| 3 Non-return Valve | 9 Thermostatic Mixing Valve |
| 4 Safety group (7 bar / 0,7 MPa) | A Cold Water Inlet |
| 5 Drainage Siphon | B Hot Water Outlet |
| 6 Expansion Vessel | C Recirculation |



It is necessary to install a safety device at the cold water inlet of the appliance. The safety device must be in compliance with the standard EN 1487:2002, maximum pressure 7 bar (0.7 MPa) Water must not be stopped from flowing from the safety device to the deposit by any sort of accessory.

The safety device must be connected with piping whose diameter is not less than the cold water inlet coupling. The discharge must be connected to a sewage siphon or, if this is not possible, elevated to a distance of at least 20 mm from the pavement to allow visual inspection;

To prevent high pressure from main water supply, install a pressure reduction valve set to 3 bar (0.3 MPa).



The Manufacture is not responsible for damage related to not following these recommendations/ warnings.



WARNING / DANGER



The water you use may contain impurities and/or substances damaging to the system and even harmful to your health. Make sure you use water with quality fitting for home consumption. The following table indicates some parameters that, when exceeded, must be chemically treated.

Hardness (°dH)	pH	Treatment
3,0 - 20,0	6,5 - 8,5	No
3,0 - 20,0	<6,5 - >8,5	Yes
<3,0 - >20,0	-	Yes

4.5. Thermodynamic Group Access

To access the equipment machine it is necessary to remove the helmet (covering the upper part). If the installation local has space restrictions that do not allow the helmet to be removed from above and whose possible access to the machine is only frontal, the following disassembly and assembly procedure must be followed:

1. Disengage the air insufflation and extraction ducts from the top of the equipment;
2. Unscrew the two fastenings on the front of the equipment, lift the helmet slightly and turn the helmet 180°;
3. Unscrew 2 of the fasteners (on the same side) from the helmet union;
4. With the helmet open, rotate again 180° to remove the helmet from the front.
5. To assemble the helmet, exactly the same steps mentioned must be carried out in reverse.

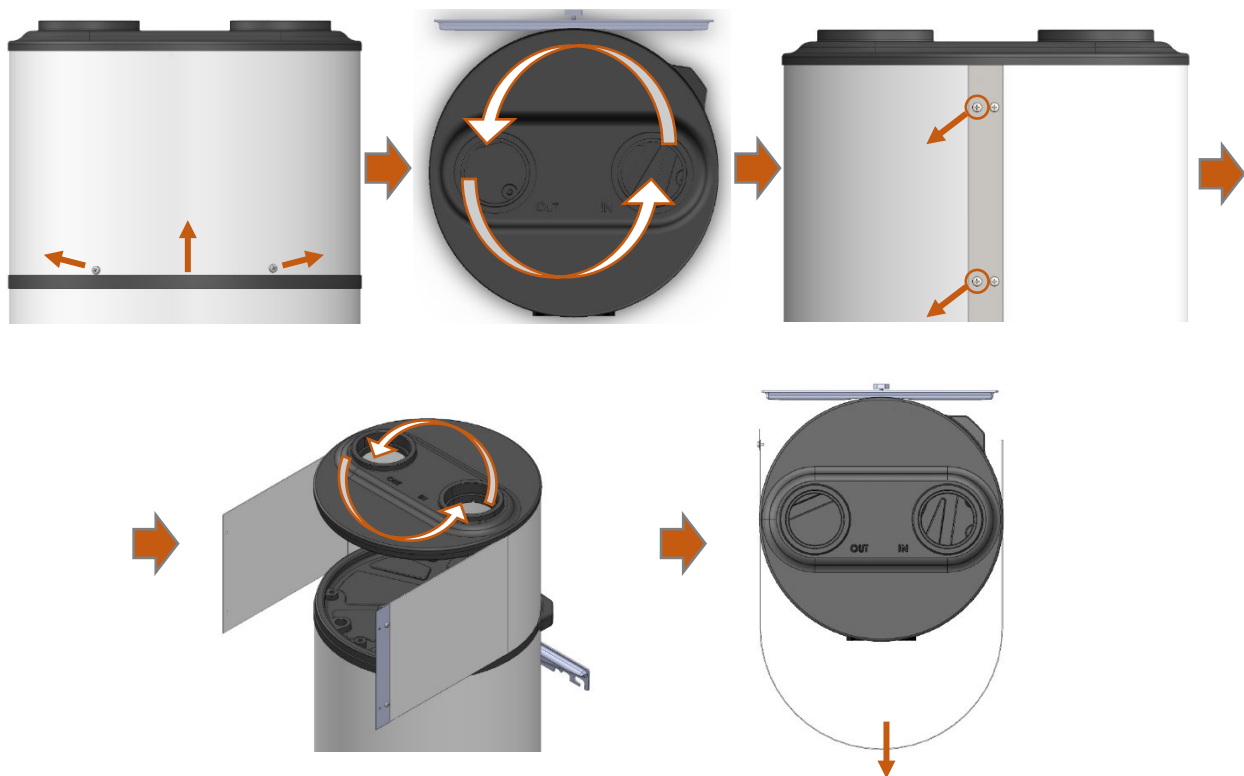

4.6. Condensates

During operation, condensation may occur. These condensates are collected in the drip tray and drained through a hole at the back of the tray. The installer must connect the condensate hose supplied by the manufacturer and direct the condensates to the drainage system or drainage siphon.



The condensate hose must not be bent/pressed and must be placed where it best suits the proper flow of condensates.

4.7. Electrical Connections

The thermodynamic equipment must be plugged to the power supply only after filling the storage water heater. The thermodynamic equipment comes with a mains cable, to be connected to an earthed monophasic voltage (230VAC/50HZ). The connections must comply with the standards of installation in effect in the territory or country where the thermodynamic equipment has been installed. The installation includes:

- Bipolar circuit-breaker with connection cable with section equal to or exceeding 2.5 mm
- Protection differential circuit breaker of 30 mA

If the power supply cable is damaged, it must be replaced by the manufacturer, by its customer service, or by staff with similar training.

4.8. Electrical Diagram

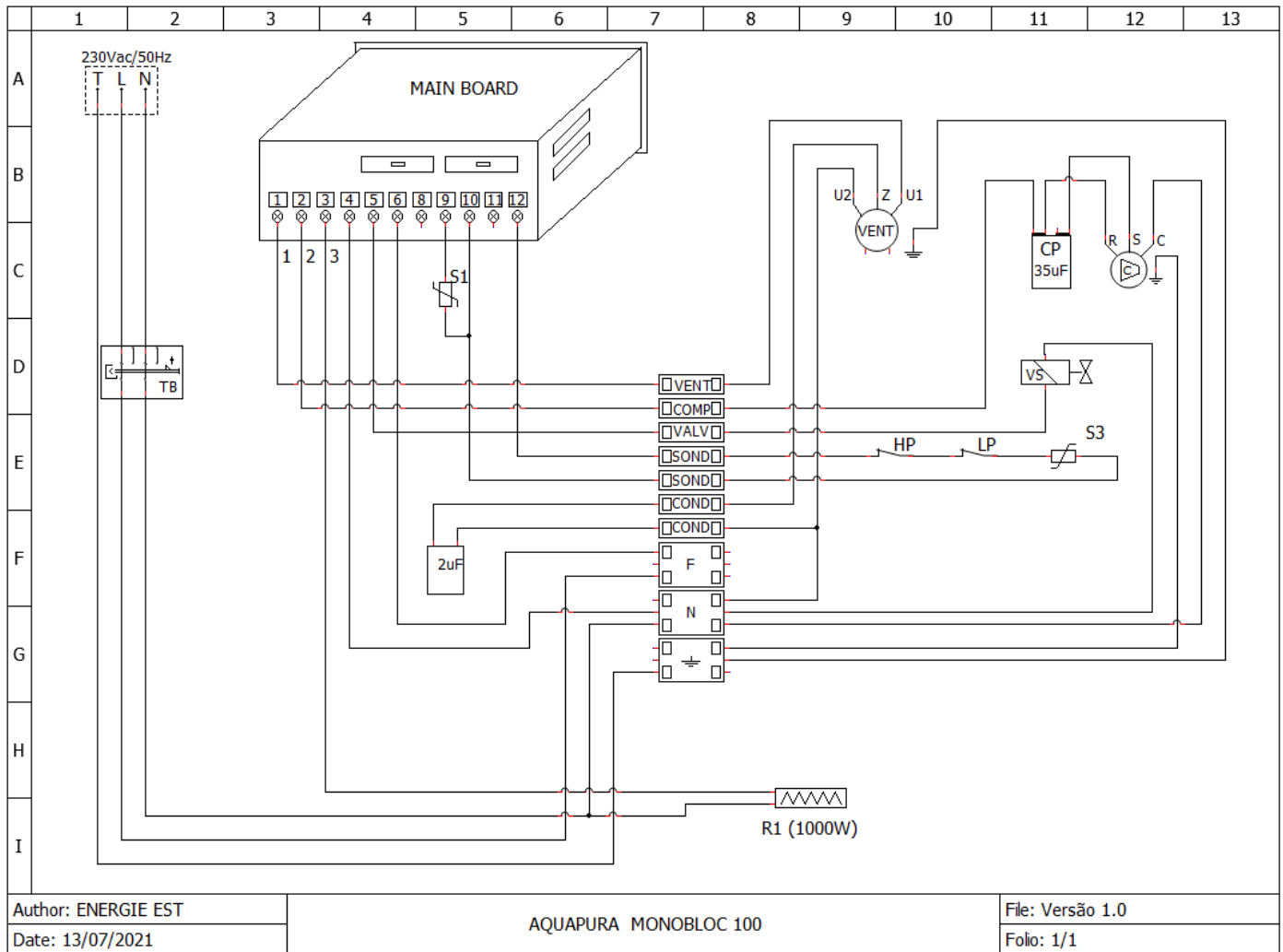

CAPTION

- | | | | |
|-------------|------------------------------|-----------|----------------------|
| R1 | Electrical backup heater | HP | High pressure switch |
| S1 | Water temperature probe | LP | Low pressure switch |
| S3 | Evaporator temperature probe | C | Compressor |
| VENT | Fan | TB | Safety thermostat |
| N | Neutral | SV | Solenoid valve |
| F | Phase | | |

5. CONTROL and PROGRAMMING

5.1. Control Panel

The control panel is simple and intuitive. Allows the configuration of various operating parameters depending on the operating mode selected by the user.



5.2. Keys (Functions)



Key	Description
	ON/OFF Switch on and off controller; Exit menu, submenu or cancel a function;
	Unlock keyboard; Enter menu; Confirm parameters within menus or submenus;
	Manual activation of the defrosting cycle (the defrosting function will only start if the defined conditions to the beginning of the cycle are satisfied); Pointer to increase values.
	Select operation mode; Pointer to decrease values.

5.3. Display

Led	Description
	Compressor's led; If the led is: <ul style="list-style-type: none"> On, the compressor is functioning; Blink, the compressor is temporizing to start.
	Defrost cycle active
	Fan's led; If the led is: <ul style="list-style-type: none"> On, the fan is functioning; Blink, the fan is temporizing to start.
AUX	Electrical resistance of functioning support
	Maintenance led, verify compressor
°C	Information on the display in Celsius degrees
°F	Information on the display in Fahrenheit
HACCP	Alarm indication led
	ON/OFF equipment. If the led is: <ul style="list-style-type: none"> On means that the equipment is off; Off means that the equipment is on.

5.4. User Interface

1 - ON/OFF equipment

Press the key   to turn on or turn off the equipment.

Note: After turning on the equipment, you will have to wait 5 min until the equipment starts operating (compressor start timer).

2 - Block/ Unlock keyboard

To unlock the keyboard, press the key  **SET** for 4s. Keyboard lock is automatic and occurs 30s after any keyboard inactivity. When the keypad locks, the following message is shown on the display for 1s "**Loc**".

3 – Information on the display while operating





During operation, the information shown on the display corresponds to the water temperature.





4 – Operation mode running

To check the current operating mode click on the button **FNC** , the adopted mode will automatically appear on the display.

To change the operating mode press the key **FNC**  for 2s, with the cursors   or **FNC**  select the operating mode, once selected press the key  **SET** to confirm/activate the new operating mode.

5 – Change Setpoint

To change the operating setpoint click on the button  **SET** and immediately will appear on the display SP1, to switch to SP2 or SP3 use the cursors   or **FNC** .

After selecting the parameter to change click on the button  **SET** to enter the parameter and with the cursors   (increase) or **FNC**  (decrease) the value of the parameter. To confirm, click on the button again  **SET**.

Parameter	Description
SP1	Compressor operating setpoint in ECO mode. Compressor and resistance operating setpoint in OBS mode if OBS mode is active during ECO function.
SP2	Compressor and resistance operating setpoint in AUT mode. Compressor and resistance operating setpoint in OBS mode if OBS mode is active during AUT function.
SP3	Setpoint to activate OBS mode, that is, the function only starts working when the water temperature in the water heater is lower than SP3 .

5.5. Operating Modes

The heat pump is programmed to work in three modes of operation:

ECO (ECONOMY) operating mode, the equipment works only as a heat pump to heat the water in the water heater. The operating setpoint adopted corresponds to parameter **SP1**.

During ECO operating mode the compressor works in parallel with the fan and the electrical heater is always off.

NOTE: In ECO mode we obtain greater efficiency, allowing greater savings for the user.

AUT (CONFORT) operating mode, the equipment works as a heat pump plus electrical heater to heat the water in the water heater. The operating setpoint adopted by the compressor and the electrical heater corresponds to parameter **SP2**.

During **AUT** operating mode the compressor works in parallel with the fan and the electrical heater.

OBS (BOOST) operating mode the equipment works as a heat pump plus electrical heater to heat the water in the water heater. The operating setpoint adopted by the compressor and the electrical heater corresponds to parameter **SP1**.

During **OBS** operating mode the compressor works in parallel with the fan and the heater.

NOTE 1: The OBS operating mode lasts for one cycle if the operating mode prior to the mode change is ECO mode, that is, after active and reaching the respective setpoint (SP1), it is automatically cancelled and the equipment assumes by default the previous operating mode (ECO).

NOTE 2: In ECO mode it is only possible to activate the OBS function when the water temperature in the water heater is lower than SP3.

NOTE 3: If the OBS operating mode is active during the AUT operating mode, the equipment will work alternately between AUT mode and OBS mode, that is, if the water temperature drops to below SP3 the controller assumes the OBS function until reaching the SP2 setpoint. If the water temperature remains above SP3 the controller assumes AUT mode.

5.6. Anti-Legionella Function

The electronic control is enabled with the Anti-Legionella function, which consists of a water heating cycle up to 65 °C for a suitable period of time to prevent the formation of germs in the tank.

The Anti-Legionella function is automatically activated every 30 days.

6. ERRORS

The installation, assembly and repair of the equipment can only be carried out by qualified technicians.

Symbols	Description	Problem / Checking
Pr1	Probe 1 damaged	Check integrity of probe connections on the controller; Measure probe resistance (NTC 10K Ω , resistance at 25°C equals \pm 10K Ω); Replace probe;
Pr2	Probe 2 damaged	
Pr3	Probe 3 damaged	
rtc	Alarm time setting	Set the time, date and day of the week;
AL	Temperature too low	Temperature in the water heater below 10°C.
AH	Temperature too high	Shorted probe: Check integrity of probe connections on the controller; Measure probe resistance (NTC 10K Ω , resistance at 25°C equals \pm 10K Ω); Replace probe;
PF	Power failure alarm	Click on a random button; Check electrical connections.
LHP	Pressure switch alarm	Turn the equipment off and on.
HP	High pressure alarm	Turn the equipment on and off. Check electrical connections. Obstruction in the refrigeration circuit.
FiL	Compressor maintenance alarm	Turn the equipment on and off.
UtL	Evaporator failure alarm	Turn the equipment on and off.

7. PROBE CHART

The probes installed in the equipment, probe S1, S2, S3, are of the NTC 10k Ω @25°C type.

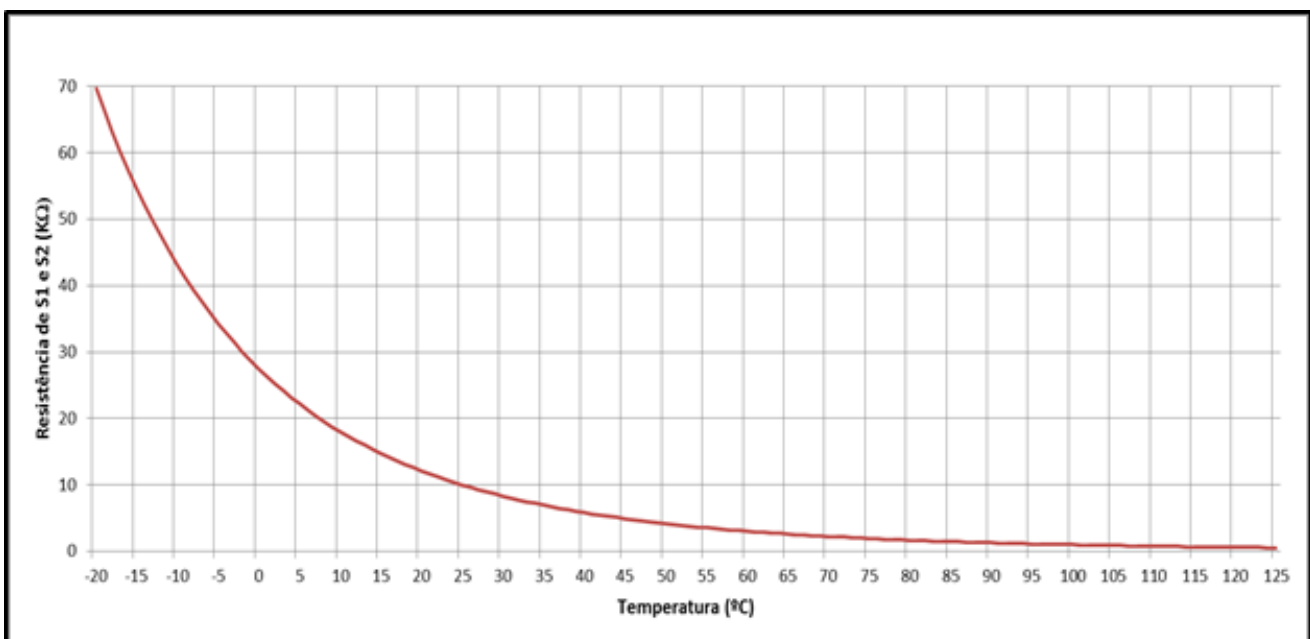



8. TROUBLESHOOTING

Problem	Possible Causes	How to Proceed
Failure in electronic board	Falta de alimentação	Check the power supply. Check the corresponding circuit breaker.
	Cable damaged or disconnected	Check the integrity of the electronic board's electric circuit.
Low water temperature or lack of hot water	Low temperature programmed as the set-point	Adjust the temperature of the set-point. 55°C from factory.
	Error activation	Check the presence of error on electronic board and consult the table of errors.
	Cable damaged or disconnected	Check the connection of equipment to the plug Check that the corresponding circuit-breaker is connected. Check the integrity of the cables. Check that the electrical cable is disconnected from the power board. Check electric protection (fuse).
	Equipment or compressor off	See chap. 5.4 for starting the equipment.
	Use of large amount of hot water	Change the equipment to "OBS" mode for a fast water heating.
	Return of hot water into the cold water circuit (safety device incorrectly installed or damaged)	Shut off the cold water supply valve to switch off the safety device. Open a hot water tap. Wait 10 minutes and if you get hot water, replace the faulty plumbing and/or proceed with the correct positioning of the safety device. Clean the filter of the safety device.
	ECO mode selected and external temperature really low	Change the equipment to "AUT" mode to start automatic management of system Change the equipment to "OBS" mode for a fast water heating.
	Electric heater OFF	Make sure the backup electric heater has power supply.
Water is too hot and/or there is steam	Problem with the probe	Check error display on electronic board
	Problem with the safety thermostat	Check correct running of safety thermostat
Reduced operation of the heat pump circuit and consequently activated resistance, in "Aut" mode	Extremely low ambient temperature	The operation of the equipment depends on the weather conditions.
	Low inlet water temperature	The operation of the equipment depends on the temperature of the inlet water.
	Installation with low electrical voltage	Make sure that the indicated voltage value is supplied to the installation.
	Problems in the heat pump system	Check the display for an error continuously.
	Clogged or frozen evaporator	Clean the evaporator.
	Fan Problems	Check wiring status.

Problem	Possible Causes	How to Proceed
Low hot water flow rate	Hydraulic circuit blocked	Check the condition of the hydraulic circuit
Water leakage by the security group	Absence or poor sizing of the expansion vessel (if leakage is intermittent)	Installation and/or correct sizing of an expansion vessel
	High pressure in the network (if leakage is continuous)	Checking the pressure reducing valve (if fitted). Installation of a pressure reducing valve (if absent).
Abnormally high and constant electrical consumption	Losses or obstruction in the refrigerant circuit	Check that the piping is not damaged. Use proper equipment to check leaks in the circuit.
	Adverse environmental conditions	
Electrical heater doesn't work	Safety thermostat failure or activation	Check the safety thermostat.
	Electrical heater damaged	Check the electrical heater
Bad odor	Absence of siphon or waterless siphon	Install and certify the syphon has water.
Undrained Condensates	Clogged condensate evacuation system	Clean the condensation circuit
	Clogged condensate drain pipe	Check the drain pipe
Magnesium anode degradation	Over time, the magnesium anode will be consumed. This consumption is normal, resulting of scarification to prevent corrosion of the tank. The consumption rate differs depending on the quality of your water. Is recommended to check the status of your anode at least every year.	

9. SYSTEM MAINTENANCE

 WARNING	<p>Before undertaking any maintenance operation on the equipment, make sure it is not plugged to the power supply! Wait until the fan comes to a complete stop.</p>
---	--

	<p>Although the fluid in the cooling circuit is environmentally-friendly, it must not be released into the atmosphere. Forms of recovery must be arranged.</p>
---	---

9.1. General Inspection

During the equipment’s useful life, the owner should carry out a general inspection of the equipment, according to the place where the equipment is set up:

- External cleaning of equipment and surrounding areas with a wet cloth;
- Visual inspection of the whole equipment, with the purpose of detecting possible leaks and damaged devices.

9.2. Empty the Water Storage

 WARNING	<p>Remember that the water in the storage water heater is at a high temperature, so there is an associated risk of burns. Before emptying the storage water heater, allow the water temperature to drop to a level that avoids burns.</p>
--	--

After ensuring the water temperature is at a safe level that will avoid burns, follow this procedure:

- Unplug the system from the power supply
- Shut off the water supply valve and open a hot water tap
- Open the system discharge valve

9.3. Filter of Reduction Valve

To periodically clean the filter of the reduction valve, you should:

- Shut off the water supply.
- Turn anti-clockwise until you remove tension from the spring
- Remove the handle
- Remove filter and clean

9.4. Condensate circuit

Make sure you check the condensate draining system and the drip tray in the maintenance and cleaning service routines of your system. Clean the drip tray used as it may contain accumulated dust from the out- side, which may obstruct the condensates drainage holes. Make sure the holes and the condensate outlet pipe are not obstructed.

9.5. Cleaning Air Circuit

Make sure the air inlet filters are not obstructed, if applicable. Inspect at least once a year. The evaporator may have deposited dust. Clean it also, but be careful with its fins.

 WARNING	<p>The evaporator’s fins are quite thin, so there is additional risk of injuries. Take care not to damage them.</p>
---	--

9.6. Safety Thermostat

The safety thermostat is deactivated whenever there is an anomaly in the system, so every time you plan

to activate it, find out what happened that caused it to change its status mode.

If you were not able to determine what happened and it is still deactivated, contact customer service to have your problem solved.

END

Warranty

This warranty covers all defects to the confirmed materials, excluding the payment of any type of personal damage indemnity caused directly or indirectly by the materials.

The periods indicated below start from the purchase date of the apparatus, 6 months at the latest from the leaving date from our storage warehouses.

Water Cylinder

(Domestic and Industrial)

5 Years: Stainless Steel (3+2 Years)*

5 Years Enamelled (3+2 Years)*

Manufacturer Warranty

Thermodynamic

Solar Panel

10 years against corrosion

Electrical components and moving parts:

- Bloco Termodinâmico
 - Solarbox
 - Bloco Combi
 - Monobloc (except cylinder)
 - DHW
- 3 Years

*The warranty extension of 2 years, against corrosion of the internal tank (Enamelled / Stainless Steel), is conditioned to the submission of:

- Warranty and Check Sheet at maximum 15 days after the installation.
- Documental evidence of the magnesium anode replacement (if applicable).
- Pictures of the installation where it's shown safety group, expansion vessel, hydraulic and electrical connections

In case of warranty, the parts replaced are property of the manufacturer. A repair under the warranty is not reason for an extension of its term.

Warranty Exclusions

The warranty ceases to be effective when the apparatus is no longer connected, used or assembled in accordance with manufacturer instructions, or if there has been any form of intervention by unauthorized technicians, has the appearance of modifications and/or if the series number appears to have been removed or erased. The equipment should be installed by qualified technicians according to the rules in effects and/or the rules of the trade, or the instructions of our technical services. Further exclusions from warranty:

- Hot water tanks have been operating in water with the following indexes:
 - o Active chlorine > 0.2 ppm
 - o Chlorides > 50 mg/l (Inox)
 - o Hardness > 200 mg/l
 - o Conductibility > 600µS/cm (200C)
 - o PH < 5,5 or PH > 9 (Sorensen at 200C).
 - o If one of the water parameters has a greater value than stipulated by directive 236/98 (Portugal) or equivalent standard in the costumer's country
- Parts are subject to natural wear and tear – levers, switches, resistances, programmers, thermostats, etc.
- Breakdown due to incorrect handling, electrical discharges, flooding, humidity or by im- proper use of the apparatus.
- The warranty lapses if it is transferred to another owner, even if within the guarantee period.
- The warranty lapses if this certificate is incorrectly filled in, if it is violated or if it is re- turned after more than 15 days have passed since the purchase date of the apparatus.

ATTENTION: Technical assistance costs even within the warranty period shall be supported by the customer (Km and assistance time). In cases where there is no justifiable breakdown and subsequent need for technical assistance, the client will pay for lost technical assistance time.

NOTE: This sheet must be properly filled, signed and stamped by the installer / reseller and returned to ENERGIE EST, Lda., otherwise the warranty will not be validated.
Send this installation sheet to warranty@energie.pt, writing the serial number of the equipment as subject.



ErP
READY

APPLIC TO
EUROPEAN
DIRECTIVE
FOR ENERGY
RELATED
PRODUCTS



Informação mais detalhada em
energie.pt



Siga-nos em
ENERGIE PORTUGAL

Morada Zona Industrial de Laúndos, Lote 48
4570-311 Laúndos - Póvoa de Varzim PORTUGAL
Coordenadas GPS N 41 27.215' , W 8 43.669'
Telefone + 351 252 600 230

Fax + 351 252 600 239
E-mail energie@energie.pt
Web www.energie.pt

Projeto co-financiado por:



UNIÃO EUROPEIA
Fundos Europeus
Estruturais e de Investimento

O presente folheto foi criado apenas para informar e não constitui uma oferta contratual para a ENERGIE Est Lda. A ENERGIE Est Lda. compilou o conteúdo deste folheto de acordo com o melhor dos seus conhecimentos. Não é dada qualquer garantia expressa ou implícita no que toca à totalidade, precisão, fiabilidade ou adequação para um determinado fim do seu conteúdo e dos produtos e serviços que apresenta. As especificações estão sujeitas a alterações sem aviso prévio. A ENERGIE Est Lda. rejeita explicitamente quaisquer danos diretos ou indiretos, no seu sentido mais amplo, resultantes ou relacionados com a utilização e/ou interpretação deste folheto.